











**AUTO·MOW**

**User Manual**



# The Cube

Screws :	(A)		2Pcs	(E)		3.5*20 4+1 Pcs
	(B)		3.5*30 12+1 Pcs	(F)		2 Pcs
	(C)		5 Pcs	(H)		4 Pcs
	(D)		2 Pcs	(I)		3.5*25 2+1 Pcs
	(J)		3.0*18 8+1 Pcs			

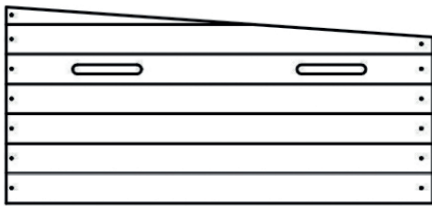

① 1 Pc

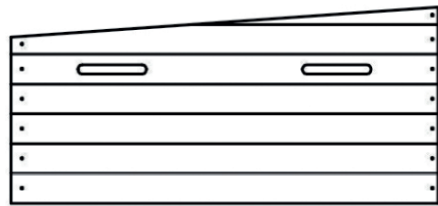

② 1 Pc

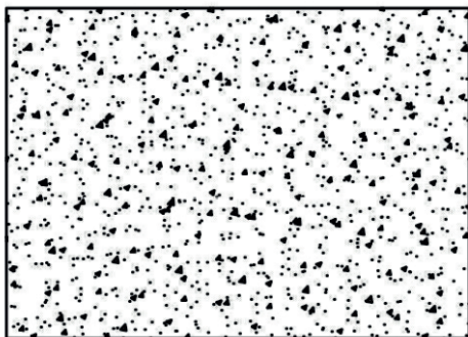

③ 1 Pc



④ 1 Pc

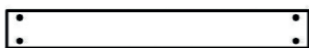

⑤ 1 Pc

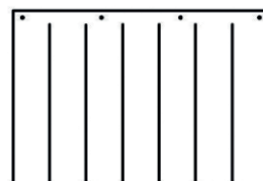

⑥ 1 Pc

### Step 1

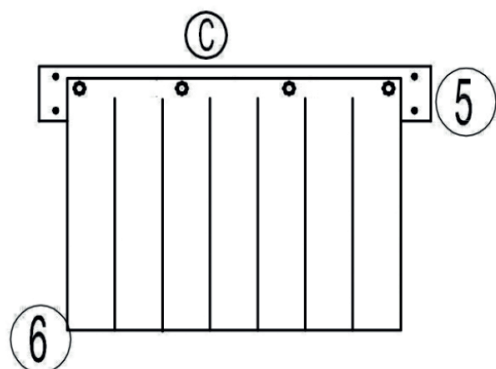

ⓐ ⓐ 5 Pcs

### Step 2

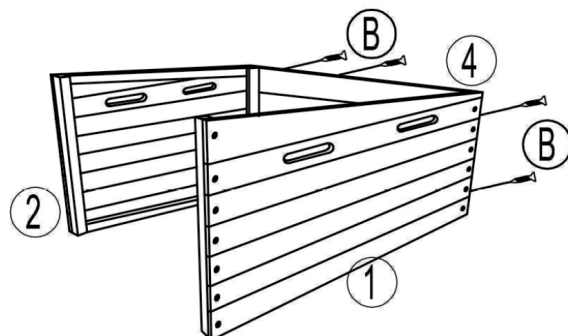

ⓐ 3.5\*30 4 Pcs

### Step 3

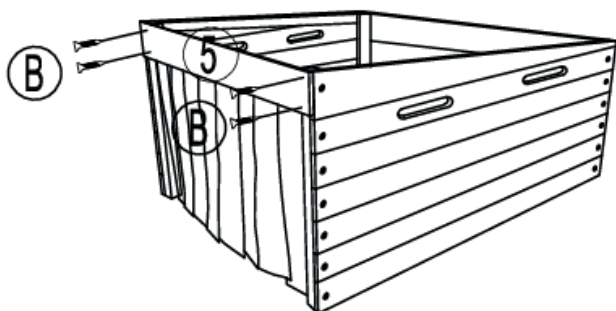

ⓐ 3.5\*30 4 Pcs

### Step 4

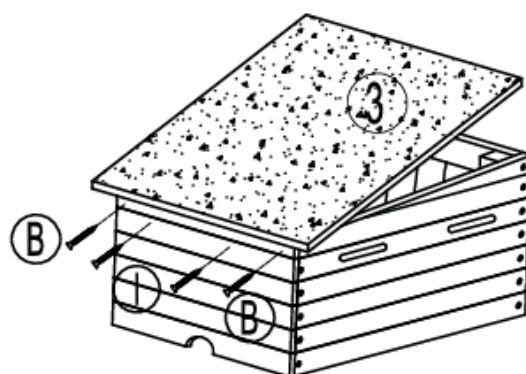

ⓐ 3.5\*30 2 Pcs

ⓐ 3.5\*25 2 Pcs

Step 5

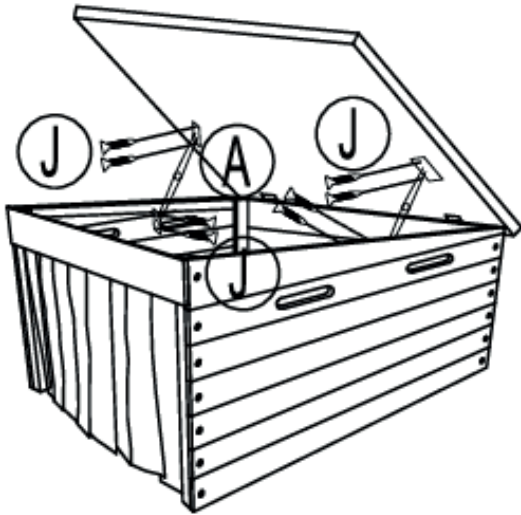

ⓐ  3.0\*16 8 Pcs

Step 6

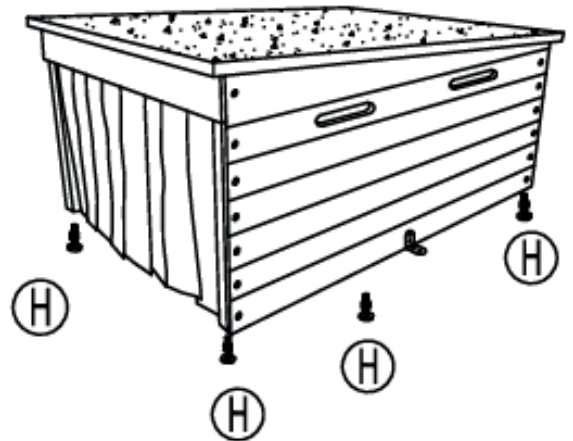

ⓓ  4 Pcs

Step 7

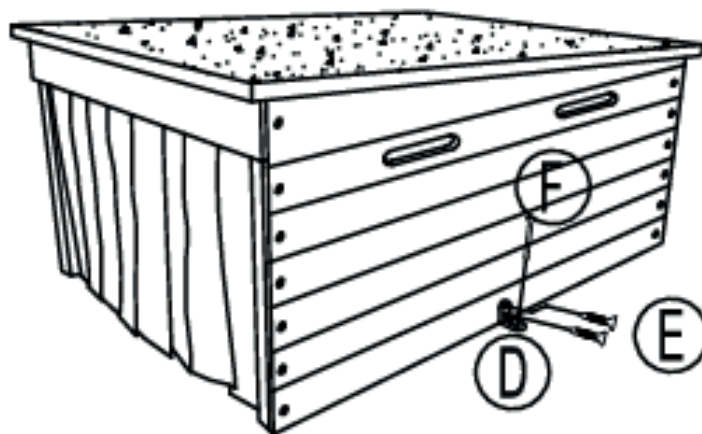

ⓓ  2 Pcs

ⓔ  3.5\*20 4 Pcs

ⓕ  2 Pcs